

FEATURES

- 10 years minimum data retention in the absence of external power
- Data is automatically protected during power loss
- Replaces 512k x 8 volatile static RAM, EEPROM or Flash memory
- Unlimited write cycles
- Low-power CMOS
- Read and write access times as fast as 70 ns
- Lithium energy source is electrically disconnected to retain freshness until power is applied for the first time
- Full $\pm 10\%$ V_{CC} operating range (DS1250Y)
- Optional $\pm 5\%$ V_{CC} operating range (DS1250AB)
- Optional industrial temperature range of -40°C to $+85^{\circ}\text{C}$, designated IND
- JEDEC standard 32-pin DIP package
- New PowerCap Module (PCM) package
 - Directly surface-mountable module
 - Replaceable snap-on PowerCap provides lithium backup battery
 - Standardized pinout for all nonvolatile SRAM products
 - Detachment feature on PCM allows easy removal using a regular screwdriver

PIN ASSIGNMENT

A18	1	32	V_{CC}
A16	2	31	A15
A14	3	30	A17
A12	4	29	\overline{WE}
A7	5	28	A13
A6	6	27	A8
A5	7	26	A9
A4	8	25	A11
A3	9	24	\overline{OE}
A2	10	23	A10
A1	11	22	\overline{CE}
A0	12	21	DQ7
DQ0	13	20	DQ6
DQ1	14	19	DQ5
DQ2	15	18	DQ4
GND	16	17	DQ3

32-Pin ENCAPSULATED PACKAGE
740-mil EXTENDED

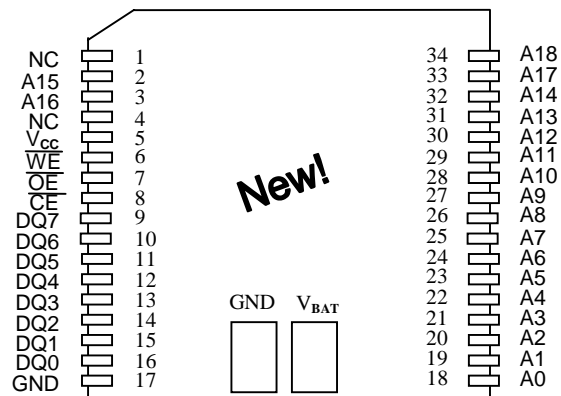

34-Pin POWERCAP MODULE (PCM)
(USES DS9034PC POWERCAP)

PIN DESCRIPTION

A0 - A18	- Address Inputs
DQ0 - DQ7	- Data In/Data Out
\overline{CE}	- Chip Enable
\overline{WE}	- Write Enable
\overline{OE}	- Output Enable
V_{CC}	- Power (+5V)
GND	- Ground
NC	- No Connect

DESCRIPTION

The DS1250 4096k Nonvolatile SRAMs are 4,194,304-bit, fully static, nonvolatile SRAMs organized as 524,288 words by 8 bits. Each complete NV SRAM has a self-contained lithium energy source and control circuitry which constantly monitors V_{CC} for an out-of-tolerance condition. When such a condition occurs, the lithium energy source is automatically switched on and write protection is unconditionally enabled to prevent data corruption. DIP-package DS1250 devices can be used in place of existing 512k x 8 static RAMs directly conforming to the popular byte-wide 32-pin DIP standard. DS1250 devices in the PowerCap Module package are directly surface mountable and are normally paired with a DS9034PC PowerCap to form a complete Nonvolatile SRAM module. There is no limit on the number of write cycles that can be executed and no additional support circuitry is required for microprocessor interfacing.

READ MODE

The DS1250 executes a read cycle whenever \overline{WE} (Write Enable) is inactive (high) and \overline{CE} (Chip Enable) and \overline{OE} (Output Enable) are active (low). The unique address specified by the 19 address inputs ($A_0 - A_{18}$) defines which of the 524,288 bytes of data is to be accessed. Valid data will be available to the eight data output drivers within t_{ACC} (Access Time) after the last address input signal is stable, providing that \overline{CE} and \overline{OE} (Output Enable) access times are also satisfied. If \overline{OE} and \overline{CE} access times are not satisfied, then data access must be measured from the later-occurring signal (\overline{CE} or \overline{OE}) and the limiting parameter is either t_{CO} for \overline{CE} or t_{OE} for \overline{OE} rather than address access.

WRITE MODE

The DS1250 executes a write cycle whenever the \overline{WE} and \overline{CE} signals are active (low) after address inputs are stable. The later-occurring falling edge of \overline{CE} or \overline{WE} will determine the start of the write cycle. The write cycle is terminated by the earlier rising edge of \overline{CE} or \overline{WE} . All address inputs must be kept valid throughout the write cycle. \overline{WE} must return to the high state for a minimum recovery time (t_{WR}) before another cycle can be initiated. The \overline{OE} control signal should be kept inactive (high) during write cycles to avoid bus contention. However, if the output drivers are enabled (\overline{CE} and \overline{OE} active) then \overline{WE} will disable the outputs in t_{ODW} from its falling edge.

DATA RETENTION MODE

The DS1250AB provides full functional capability for V_{CC} greater than 4.75 volts and write protects by 4.5 volts. The DS1250Y provides full functional capability for V_{CC} greater than 4.5 volts and write protects by 4.25 volts. Data is maintained in the absence of V_{CC} without any additional support circuitry. The nonvolatile static RAMs constantly monitor V_{CC} . Should the supply voltage decay, the NV SRAMs automatically write protect themselves, all inputs become “don’t care,” and all outputs become high-impedance. As V_{CC} falls below approximately 3.0 volts, a power switching circuit connects the lithium energy source to RAM to retain data. During power-up, when V_{CC} rises above approximately 3.0 volts, the power switching circuit connects external V_{CC} to RAM and disconnects the lithium energy source. Normal RAM operation can resume after V_{CC} exceeds 4.75 volts for the DS1250AB and 4.5 volts for the DS1250Y.

FRESHNESS SEAL

Each DS1250 device is shipped from Dallas Semiconductor with its lithium energy source disconnected, guaranteeing full energy capacity. When V_{CC} is first applied at a level greater than 4.25 volts, the lithium energy source is enabled for battery back-up operation.

PACKAGES

The DS1250 is available in two packages: 32-pin DIP and 34-pin PowerCap Module (PCM). The 32-pin DIP integrates a lithium battery, an SRAM memory and a nonvolatile control function into a single package with a JEDEC-standard 600-mil DIP pinout. The 34-pin PowerCap Module integrates SRAM memory and nonvolatile control into a module base along with contacts for connection to the lithium battery in the DS9034PC PowerCap. The PowerCap Module package design allows a DS1250 PCM device to be surface mounted without subjecting its lithium backup battery to destructive high-temperature reflow soldering. After a DS1250 PCM module base is reflow soldered, a DS9034PC PowerCap is snapped on top of the PCM to form a complete Nonvolatile SRAM module. The DS9034PC is keyed to prevent improper attachment. DS1250 module bases and DS9034PC PowerCaps are ordered separately and shipped in separate containers. See the DS9034PC data sheet for further information.

ABSOLUTE MAXIMUM RATINGS*

Voltage on Any Pin Relative to Ground	-0.3V to +7.0V
Operating Temperature	0°C to 70°C, -40°C to +85°C for IND parts
Storage Temperature	-40°C to +70°C, -40°C to +85°C for IND parts
Soldering Temperature	260°C for 10 seconds

* This is a stress rating only and functional operation of the device at these or any other conditions above those indicated in the operation sections of this specification is not implied. Exposure to absolute maximum rating conditions for extended periods of time may affect reliability.

RECOMMENDED DC OPERATING CONDITIONS

(t_A : See Note 10)

PARAMETER	SYMBOL	MIN	TYP	MAX	UNITS	NOTES
DS1250AB Power Supply Voltage	V_{CC}	4.75	5.0	5.25	V	
DS1250Y Power Supply Voltage	V_{CC}	4.5	5.0	5.5	V	
Logic 1	V_{IH}	2.2		V_{CC}	V	
Logic 0	V_{IL}	0.0		+0.8	V	

DC ELECTRICAL CHARACTERISTICS

($V_{CC}=5V \pm 5%$ for DS1250AB)

(t_A : See Note 10) ($V_{CC}=5V \pm 10%$ for DS1250Y)

PARAMETER	SYMBOL	MIN	TYP	MAX	UNITS	NOTES
Input Leakage Current	I_{IL}	-1.0		+1.0	μA	
I/O Leakage Current $\overline{CE} \geq V_{IH} \leq V_{CC}$	I_{IO}	-1.0		+1.0	μA	
Output Current @ 2.2V	I_{OH}	-1.0			mA	
Output Current @ 0.4V	I_{OL}	2.0			mA	
Standby Current $\overline{CE}=2.2V$	I_{CCS1}		5.0	10.0	mA	
Standby Current $\overline{CE}=V_{CC}-0.5V$	I_{CCS2}		3.0	5.0	mA	
Operating Current	I_{CCO1}			85	mA	
Write Protection Voltage (DS1250AB)	V_{TP}	4.50	4.62	4.75	V	
Write Protection Voltage (DS1250Y)	V_{TP}	4.25	4.37	4.5	V	

CAPACITANCE $(t_A=25^\circ\text{C})$

PARAMETER	SYMBOL	MIN	TYP	MAX	UNITS	NOTES
Input Capacitance	C_{IN}		5	10	pF	
Input/Output Capacitance	$C_{I/O}$		5	10	pF	

AC ELECTRICAL CHARACTERISTICS $(V_{CC}=5V \pm 5\%$ for DS1250AB) $(t_A: \text{See Note 10}) (V_{CC}=5V \pm 10\%$ for DS1250Y)

PARAMETER	SYMBOL	DS1250AB-70 DS1250Y-70		DS1250AB-100 DS1250Y-100		UNITS	NOTES
		MIN	MAX	MIN	MAX		
Read Cycle Time	t_{RC}	70		100		ns	
Access Time	t_{ACC}		70		100	ns	
\overline{OE} to Output Valid	t_{OE}		35		50	ns	
\overline{CE} to Output Valid	t_{CO}		70		100	ns	
\overline{OE} or \overline{CE} to Output Active	t_{COE}	5		5		ns	5
Output High Z from Deselection	t_{OD}		25		35	ns	5
Output Hold from Address Change	t_{OH}	5		5		ns	
Write Cycle Time	t_{WC}	70		100		ns	
Write Pulse Width	t_{WP}	55		75		ns	3
Address Setup Time	t_{AW}	0		0		ns	
Write Recovery Time	t_{WR1}	5		5		ns	12
	t_{WR2}	15		15		ns	13
Output High Z from \overline{WE}	t_{ODW}		25		35	ns	5
Output Active from \overline{WE}	t_{OEW}	5		5		ns	5
Data Setup Time	t_{DS}	30		40		ns	4
Data Hold Time	t_{DH1}	0		0		ns	12
	t_{DH2}	10		10		ns	13

READ CYCLE

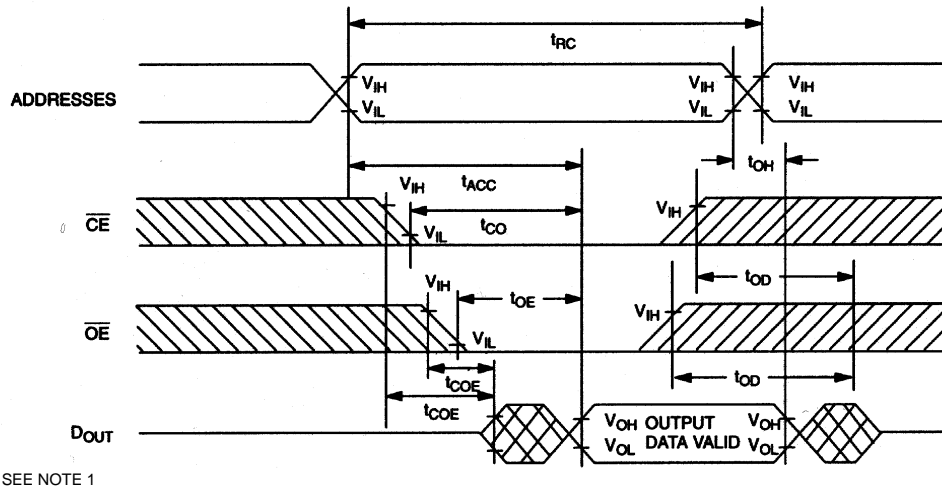

WRITE CYCLE 1

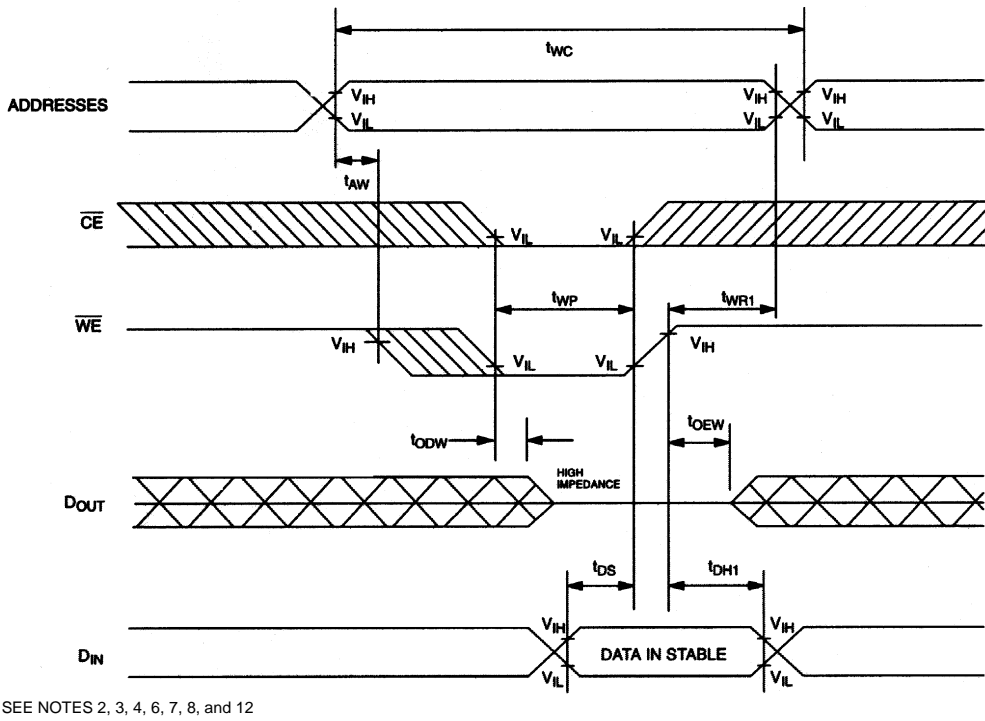

WRITE CYCLE 2

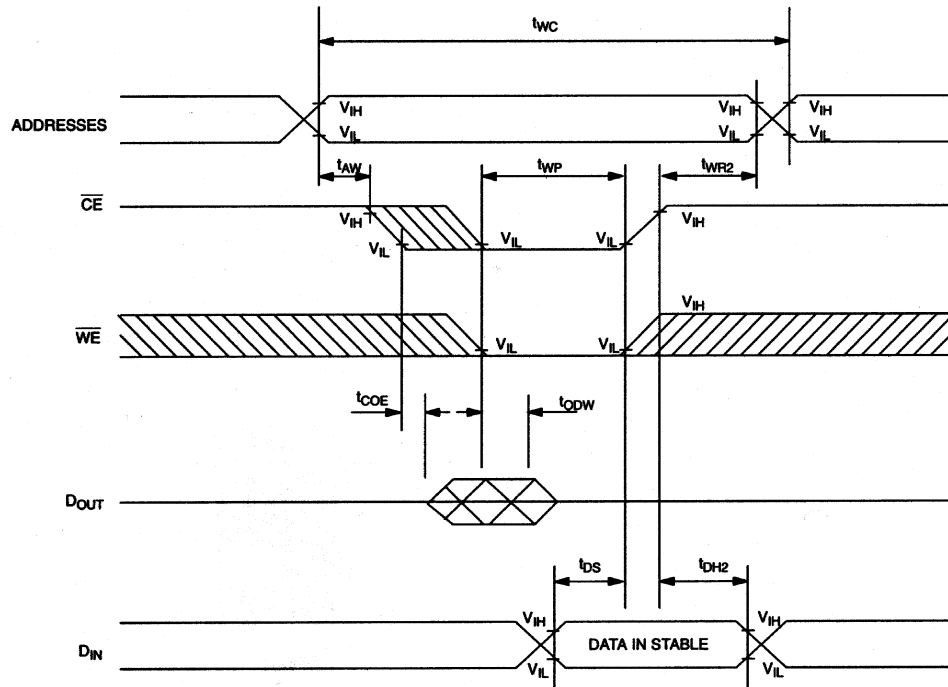

SEE NOTES 2, 3, 4, 6, 7, 8, and 13

POWER-DOWN/POWER-UP CONDITION

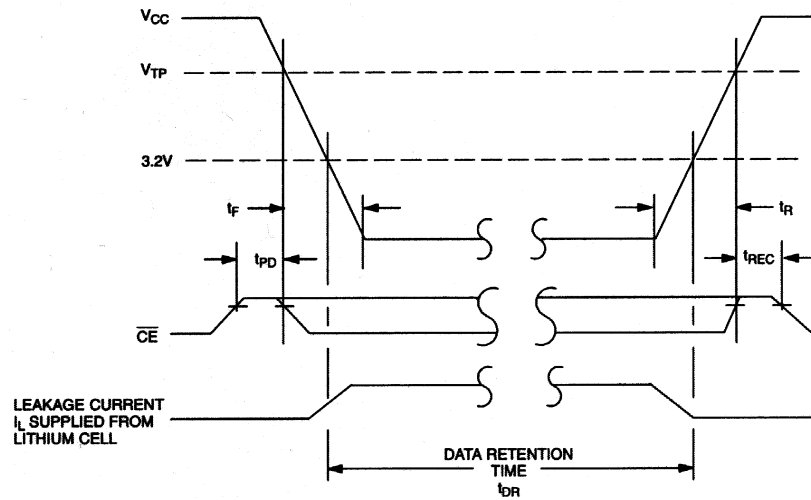

SEE NOTE 11

POWER-DOWN/POWER-UP TIMING $(t_A: \text{See Note 10})$

PARAMETER	SYMBOL	MIN	TYP	MAX	UNITS	NOTES
$\overline{\text{CE}}$, $\overline{\text{WE}}$ at V_{IH} before Power-Down	t_{PD}	0			μs	11
V_{CC} slew from V_{TP} to 0V	t_F	300			μs	
V_{CC} slew from 0V to V_{TP}	t_R	300			μs	
$\overline{\text{CE}}$, $\overline{\text{WE}}$ at V_{IH} after Power-Up	t_{REC}	2		125	ms	

 $(t_A=25^\circ\text{C})$

PARAMETER	SYMBOL	MIN	TYP	MAX	UNITS	NOTES
Expected Data Retention Time	t_{DR}	10			years	9

WARNING:

Under no circumstance are negative undershoots, of any amplitude, allowed when device is in battery backup mode.

NOTES:

- $\overline{\text{WE}}$ is high for a Read Cycle.
- $\overline{\text{OE}} = V_{IH}$ or V_{IL} . If $\overline{\text{OE}} = V_{IH}$ during write cycle, the output buffers remain in a high-impedance state.
- t_{WP} is specified as the logical AND of $\overline{\text{CE}}$ and $\overline{\text{WE}}$. t_{WP} is measured from the latter of $\overline{\text{CE}}$ or $\overline{\text{WE}}$ going low to the earlier of $\overline{\text{CE}}$ or $\overline{\text{WE}}$ going high.
- t_{DH} , t_{DS} are measured from the earlier of $\overline{\text{CE}}$ or $\overline{\text{WE}}$ going high.
- These parameters are sampled with a 5 pF load and are not 100% tested.
- If the $\overline{\text{CE}}$ low transition occurs simultaneously with or latter than the $\overline{\text{WE}}$ low transition, the output buffers remain in a high-impedance state during this period.
- If the $\overline{\text{CE}}$ high transition occurs prior to or simultaneously with the $\overline{\text{WE}}$ high transition, the output buffers remain in high-impedance state during this period.
- If $\overline{\text{WE}}$ is low or the $\overline{\text{WE}}$ low transition occurs prior to or simultaneously with the $\overline{\text{CE}}$ low transition, the output buffers remain in a high-impedance state during this period.
- Each DS1250 has a built-in switch that disconnects the lithium source until V_{CC} is first applied by the user. The expected t_{DR} is defined as accumulative time in the absence of V_{CC} starting from the time power is first applied by the user.
- All AC and DC electrical characteristics are valid over the full operating temperature range. For commercial products, this range is 0°C to 70°C . For industrial products (IND), this range is -40°C to $+85^\circ\text{C}$.
- In a power-down condition the voltage on any pin may not exceed the voltage on V_{CC} .
- t_{WR1} and t_{DH1} are measured from $\overline{\text{WE}}$ going high.
- t_{WR2} and t_{DH2} are measured from $\overline{\text{CE}}$ going high.
- DS1250 DIP modules are recognized by Underwriters Laboratory (U.L.®) under file E99151. DS1250 PowerCap modules are pending U.L. review. Contact the factory for status.

DC TEST CONDITIONS

Outputs Open
 Cycle = 200 ns for operating current
 All voltages are referenced to ground

AC TEST CONDITIONS

Output Load: 100 pF + 1TTL Gate
 Input Pulse Levels: 0 - 3.0V
 Timing Measurement Reference Levels
 Input: 1.5V
 Output: 1.5V
 Input pulse Rise and Fall Times: 5 ns

ORDERING INFORMATION

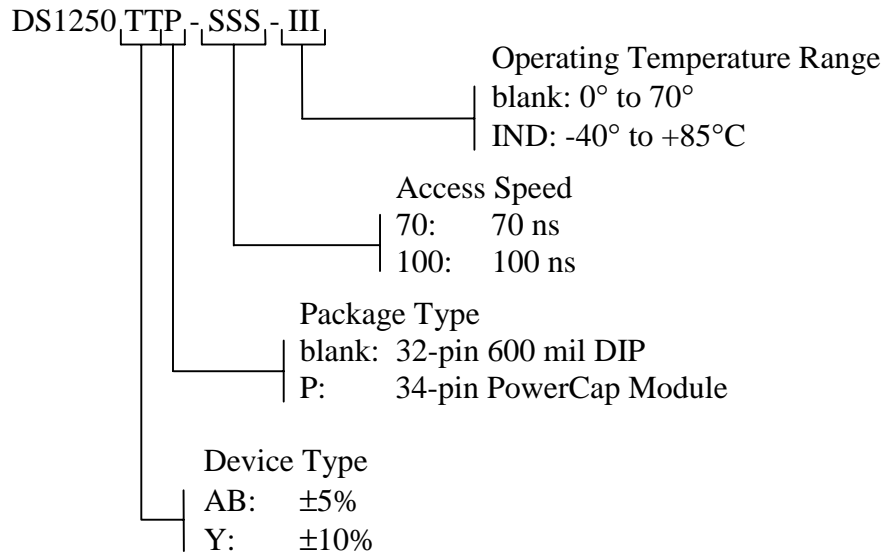

DS1250Y/AB NONVOLATILE SRAM, 32-PIN, 740 MIL-EXTENDED DIP MODULE

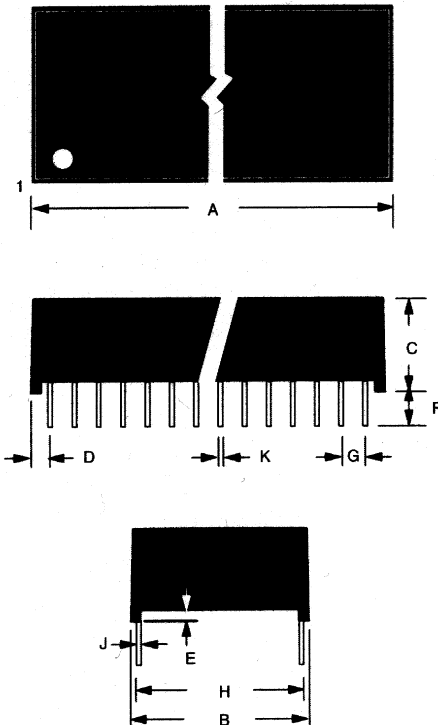

PKG	32-PIN	
DIM	MIN	MAX
A IN.	1.680	1.700
MM	42.67	43.18
B IN.	0.720	0.740
MM	18.29	18.80
C IN.	0.355	0.375
MM	9.02	9.52
D IN.	0.080	0.110
MM	2.03	2.79
E IN.	0.015	0.025
MM	0.38	0.63
F IN.	0.120	0.160
MM	3.05	4.06
G IN.	0.090	0.110
MM	2.29	2.79
H IN.	0.590	0.630
MM	14.99	16.00
J IN.	0.008	0.012
MM	0.20	0.30
K IN.	0.015	0.021
MM	0.38	0.53

DS1250Y/AB NONVOLATILE SRAM, 34-PIN POWERCAP MODULE

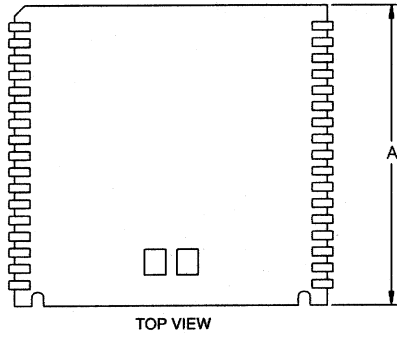

PKG DIM	INCHES		
	MIN	NOM	MAX
A	0.920	0.925	0.930
B	0.980	0.985	0.990
C	-	-	0.080
D	0.052	0.055	0.058
E	0.048	0.050	0.052
F	0.015	0.020	0.025
G	0.020	0.025	0.030

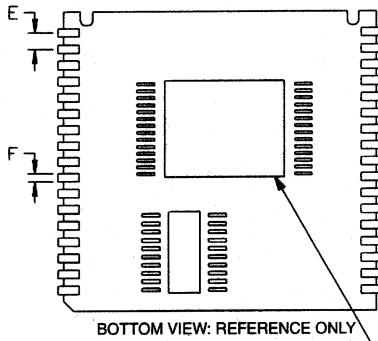
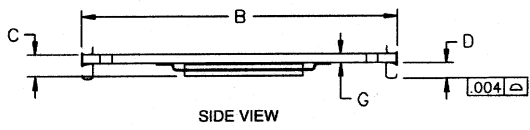

COMPONENTS AND PLACEMENTS
MAY DIFFER FROM THOSE SHOWN

DS1250Y/AB NONVOLATILE SRAM, 34-PIN POWERCAP MODULE WITH POWERCAP

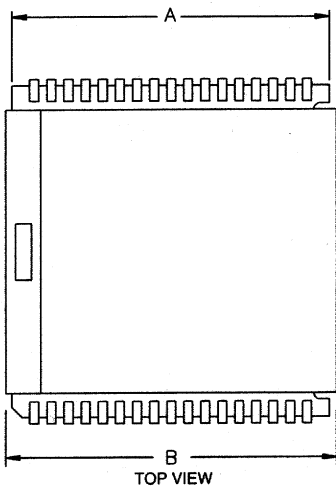

PKG DIM	INCHES		
	MIN	NOM	MAX
A	0.920	0.925	0.930
B	0.955	0.960	0.965
C	0.240	0.245	0.250
D	0.052	0.055	0.058
E	0.048	0.050	0.052
F	0.015	0.020	0.025
G	0.020	0.025	0.030

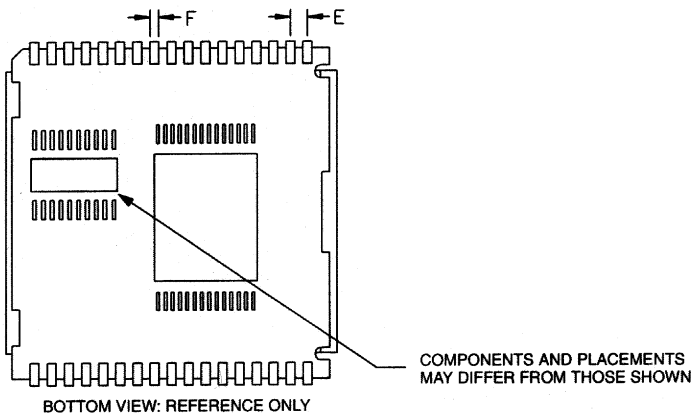
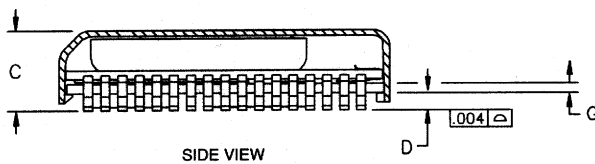

ASSEMBLY AND USE

Reflow soldering

Dallas Semiconductor recommends that PowerCap Module bases experience one pass through solder reflow oriented label-side up (live-bug).

Hand soldering and touch-up

Do not touch soldering iron to leads for more than 3 seconds. To solder, apply flux to the pad, heat the lead frame pad and apply solder. To remove part, apply flux, heat pad until solder reflows, and use a solder wick.

LPM replacement in a socket

To replace a Low Profile Module in a 68-pin PLCC socket, attach a DS9034PC PowerCap to a module base then insert the complete module into the socket one row of leads at a time, pushing only on the corners of the cap. Never apply force to the center of the device. To remove from a socket, use a PLCC extraction tool and ensure that it does not hit or damage any of the module IC components. Do not use any other tool for extraction.

RECOMMENDED POWERCAP MODULE LAND PATTERN

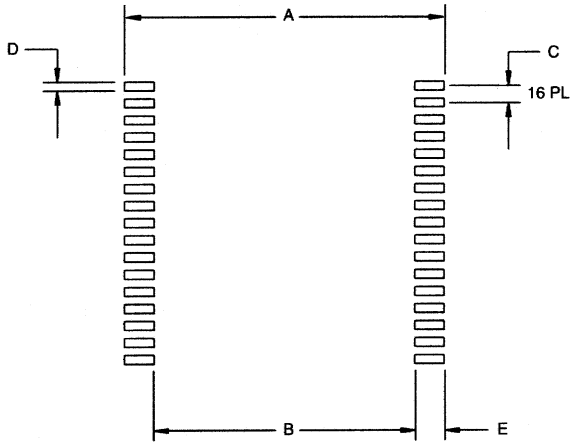

PKG DIM	INCHES		
	MIN	NOM	MAX
A	-	1.050	-
B	-	0.826	-
C	-	0.050	-
D	-	0.030	-
E	-	0.112	-

RECOMMENDED POWERCAP MODULE SOLDER STENCIL

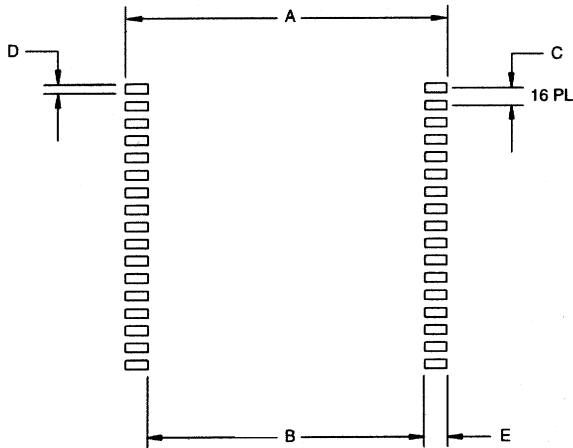

PKG DIM	INCHES		
	MIN	NOM	MAX
A	-	1.050	-
B	-	0.890	-
C	-	0.050	-
D	-	0.030	-
E	-	0.080	-