

### FEATURES

Aperture Jitter of 50ps  
 Input Range  $\pm 10V$   
 Output Current  $\pm 50mA$   
 Max Droop Rate  $5\mu V/\mu s$   
 Max 200ns Acquisition Time (0.01%; 10V Step)

### APPLICATIONS

Data Acquisition Systems  
 Peak Measurement Systems  
 Simultaneous Sample & Hold  
 Analog Delay

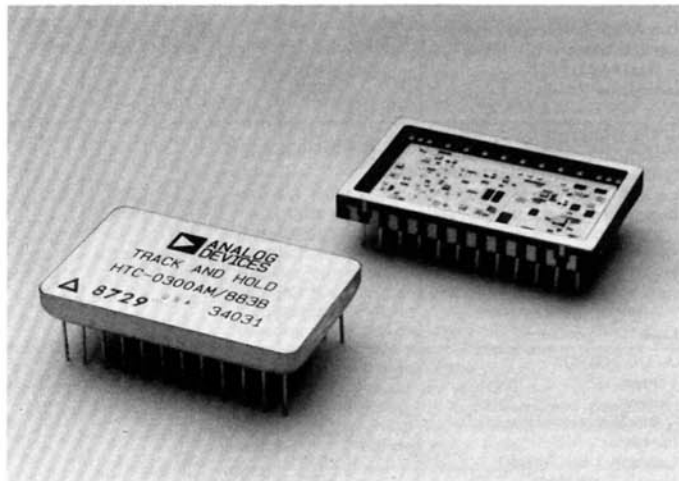

### GENERAL DESCRIPTION

The HTC-0300A is a hybrid microcircuit track-and-hold amplifier useful in a wide range of signal processing applications, including waveform measurements, analog signal delay, and signal sampling.

The unit has a typical aperture jitter of only 50 picoseconds rms; wide dynamic input range of  $\pm 10$  volts; and laser-trimmed gain and offset which preclude a need for external adjustments. Its speed and precision are the result of innovative design techniques using a high-speed op amp and DMOSFET switches. These techniques also enhance device performance in feedthrough rejection, linearity, harmonic distortion, droop rate, and output voltage swing.

### ORDERING INFORMATION

For a case temperature range of  $-25^{\circ}C$  to  $+85^{\circ}C$ , order the HTC-0300A; it is packaged in a 24-pin hermetically-sealed ceramic DIP.

A military case temperature range of  $-55^{\circ}C$  to  $+125^{\circ}C$  is available with the HTC-0300AM, HTC-0300AM/883B, and the HTC-0300ATD/883B. The first two units are housed in 24-pin metal packages, and the latter unit is packaged in a hermetic 24-pin ceramic DIP.

All versions of the HTC-0300A are manufactured in a facility which has been certified to MIL-STD-1772.

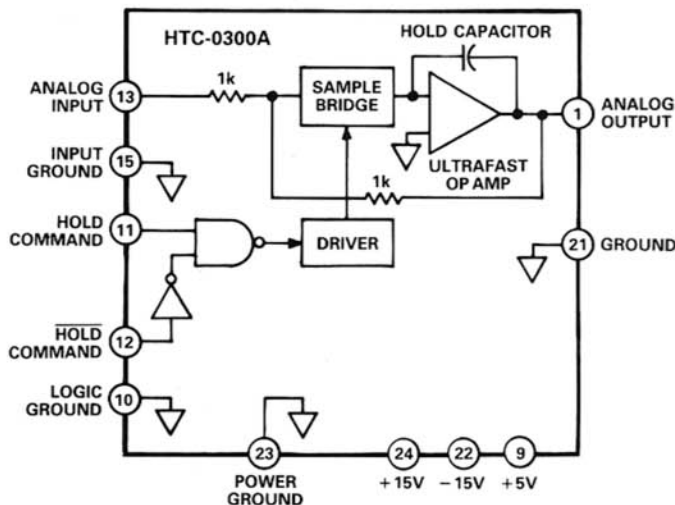

NOTES: WHEN APPLYING HOLD COMMAND TO PIN 11, CONNECT HOLD COMMAND (PIN 12) TO GROUND.  
 WHEN APPLYING HOLD COMMAND TO PIN 12, CONNECT HOLD COMMAND (PIN 11) TO +5V.

Functional Block Diagram

Information furnished by Analog Devices is believed to be accurate and reliable. However, no responsibility is assumed by Analog Devices for its use; nor for any infringements of patents or other rights of third parties which may result from its use. No license is granted by implication or otherwise under any patent or patent rights of Analog Devices.

One Technology Way; P. O. Box 9106; Norwood, MA 02062-9106 U.S.A.  
 Tel: 617/329-4700  
 Telex: 174059  
 Twx: 710/394-6577  
 Cables: ANALOG NORWOODMASS

# SPECIFICATIONS (Typical with nominal supplies, unless otherwise noted)

Parameter <sup>1,2</sup> (Conditions)	Sub-Group	Temp.	-25°C to +85°C Temp. HTC-0300A <sup>1</sup>			-55°C to +125°C Temp. HTC-0300AM ATD/883B AM/883B <sup>2</sup>			Units
			Min	Typ	Max	Min	Typ	Max	
<b>ANALOG INPUT</b> (FS = Full Scale = 10V; FSR = Full-Scale Range = 20V)									
# Voltage Range		+25°C		±10			±10	V	
# Overvoltage, No Damage		+25°C		±15			±15	V	
✓ Input Impedance (V <sub>IN</sub> = 10V; Pins 11 & 12 = "0")	1, 2, 3	Full	950	1000	1050	950	1000	1050	Ω
# Initial Offset Voltage (V <sub>IN</sub> = 0V; Pins 11 & 12 = "0")	1	+25°C		±0.5	±5.0		±0.5	±5.0	mV
<b>DIGITAL INPUT MODE CONTROL</b> (TTL Compatible)									
✓ Logic "0" Input Voltage	1, 2, 3	Full	0.0		0.8	0.0		0.8	V
✓ Logic "0" Input Current	1, 2	+25°C/ +125°C			±1.0			±1.0	μA
# Logic "0" Input Current		-55°C			±1.0			±1.0	μA
✓ Logic "1" Input Voltage	1, 2, 3	Full	2.0		5.5	2.0		5.5	V
✓ Logic "0" Input Current	1, 2	+25°C/ +125°C			±1.0			±1.0	μA
# Logic "0" Input Current		-55°C			±1.0			±1.0	μA
<b>ANALOG OUTPUT</b>									
# Voltage		+25°C		±10			±10		V
# Current (Not Short Circuit Protected)		+25°C		±50			±50		mA
# Impedance		+25°C		0.1	1.0		0.1	1.0	Ω
# Capacitive Load (See text)		+25°C		250			250		pF
# Noise in Track Mode <sup>3</sup>		+25°C							
dc to 100kHz				15			15		μV rms
dc to 1MHz				34			34		μV rms
dc to 5MHz				0.1			0.1		mV rms
<b>DC ACCURACY/STABILITY</b>									
# Gain		+25°C	-1.0			-1.0			V/V
✓ Gain Error	1	+25°C		±0.05	±0.1		±0.05	±0.1	%
	2, 3	Full						±0.15	%
✓ Gain Nonlinearity	1	+25°C		±0.005	±0.01		±0.005	±0.01	%
	2, 3	Full						±0.01	%
✓ Gain Temperature Coefficient	2, 3	Full		±0.5	+5		±0.5	+5	ppm FSR/°C
✓ Input Offset Temperature Coefficient	2, 3	Full		±3	±15		±3	±15	ppm FSR/°C
<b>TRACK (SAMPLE) MODE DYNAMICS</b> Frequency Response (V <sub>IN</sub> = 1V p-p; Pins 11 & 12 = "0")									
✓ Small Signal (-3dB) Full Power (-3dB)	4	+25°C	8	16		8	16		MHz
		+25°C		8			8		MHz
✓ Slew Rate (V <sub>IN</sub> = 10V p-p; Pins 11 & 12 = "0")	4	+25°C	220	300		220	300		V/μs
	5, 6	Full	180	300		180	300		V/μs
# Harmonic Distortion <sup>4</sup>		+25°C		80			80		dB
<b>TRACK (SAMPLE)-TO-HOLD DYNAMICS</b>									
# Aperture Time		+25°C	4	6	8	4	6	8	ns
Aperture Uncertainty (Jitter)		+25°C		50			50		ps, rms
✓ Pedestal (Offset Step)	4	+25°C		±2.5	±20		±2.5	±20	mV
✓ Pedestal Temp. Coeff.	5, 6	Full						±8	ppm FSR/°C
# Pedestal Sensitivity to +5V Supply Changes		+25°C		5			5		mV/V
Switching Transient									
✓ Amplitude	4	+25°C		180	380		180	380	mV p-p
	5, 6	Full		180	380		180	380	mV p-p
✓ Settling Time									
To 0.1%	7	+25°C		40	85		40	85	ns
To 0.1%	8	Full		40	85		40	85	ns
To 0.01%	7	+25°C		60	100		60	100	ns
To 0.01%	8	Full		60	100		60	100	ns
<b>HOLD MODE DYNAMICS</b>									
✓ Droop Rate	4	+25°C		±0.5	±5		±0.5	±5	μV/μs
	5	+125°C						±1.8	mV/μs
	6	-55°C						±5	μV/μs
✓ Feedthrough Rejection (V <sub>IN</sub> = 20V p-p@2.5MHz)	7	+25°C	64	74		64	74		dB
<b>HOLD (SAMPLE)-TO-TRACK DYNAMICS</b>									
✓ Acquisition Time to 0.1% (10V p-p Step)	7	+25°C		100	170		100	170	ns
	8	Full		100	170		100	170	ns
✓ Acquisition Time to 0.01% (10V p-p Step)	7	+25°C		160	200		160	200	ns
	8	Full		160	200		160	200	ns
Acquisition Time to 0.1% (20V p-p Step)		+25°C		110			110		ns

## OUTLINE DIMENSIONS

Dimensions shown in inches and (mm).

### HTC-0300A and HTC-0300ATD/883B

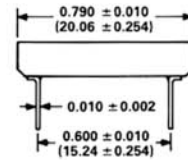
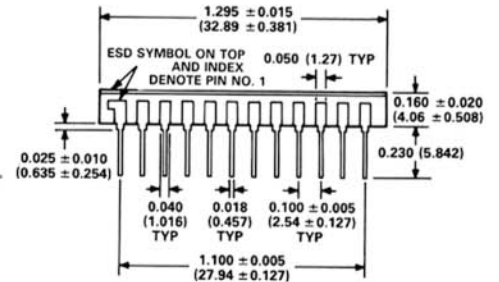

### HTC-0300AM and HTC-0300AM/883B

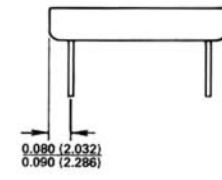
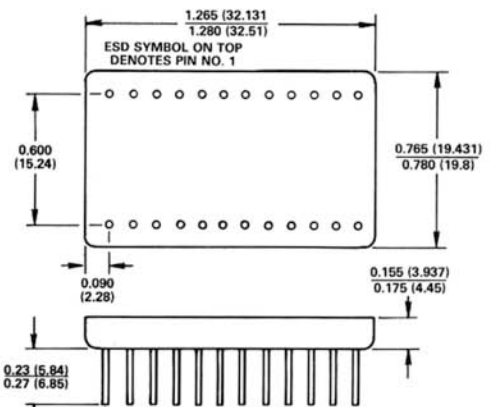

## PIN DESIGNATIONS (As viewed from bottom)

PIN	FUNCTION	PIN	FUNCTION
24	+15V	1	ANALOG OUTPUT
23	POWER GROUND	2	N/A
22	-15V	3	N/A
21	GROUND	4	N/A
20	N/A	5	N/A
19	N/A	6	N/A
18	N/A	7	N/A
17	N/A	8	N/A
16	N/A	9	+5V
15	INPUT GROUND	10	LOGIC GROUND
14	N/A	11	HOLD COMMAND
13	ANALOG INPUT	12	HOLD COMMAND

Parameter <sup>1,2</sup> (Conditions)	Sub-Group	Temp.	-25°C to +85°C Temp. HTC-0300A <sup>1</sup>			-55°C to +125°C Temp. HTC-0300AM ATD/883B AM/883B <sup>2</sup>			Units
			Min	Typ	Max	Min	Typ	Max	
<b>POWER REQUIREMENTS</b>									
Supply Voltages									
±V <sub>S</sub>		±25°C	±14.25	±15	±15.75	±14.25	±15	±15.75	V
V <sub>CC</sub> (Logic Supply)		+25°C	+4.75	+5.0	+5.25	+4.75	+5.0	+5.25	V
Supply Currents (V <sub>IN</sub> = 0V; Pins 11 & 12 = "0")									
✓ ±V <sub>S</sub>	1	+25°C		±21	±25		±21	±25	mA
	2, 3	Full		+21	+25		+21	+25	mA
✓ V <sub>CC</sub> (Logic Supply)	1	+25°C		+4	+5		+4	+5	mA
	2, 3	Full		+4	+5		+4	+5	mA
✓ Power Dissipation	1	+25°C		650	775		650	775	mW
	2, 3	Full		650	775		650	775	mW
✓ ±V <sub>S</sub> POWER SUPPLY REJECTION RATIO (PSSR) (V <sub>IN</sub> = 10V; Pins 11 & 12 = "0")	1	+25°C		±0.3	±0.5		±0.3	±0.5	mV/V
	2, 3	Full		±0.3	±0.5		±0.3	±0.5	mV/V
<b>THERMAL RESISTANCE</b>									
Case to Air, θ <sub>ca</sub> <sup>5</sup>				34			34		°C/W
Junction to Case, θ <sub>jc</sub>				28			28		°C/W
<b>MEAN TIME BETWEEN FAILURES (MTBF)<sup>6</sup></b>									
							2.1 × 10 <sup>6</sup>		Hours

**NOTES**

- ✓100% tested (See Notes 1 and 2).
- #Specification guaranteed by design; not tested.
- <sup>1</sup>HTC-0300A parameters preceded by a check (✓) are tested at +25°C ambient temperature; performance is guaranteed over the industrial temperature range (-25°C to +85°C) case temperature.
- <sup>2</sup>HTC-0300AM, ATD/883B, AM/883B parameters preceded by a check (✓) are tested at -55°C case, +25°C ambient, and +125°C case temperatures.
- <sup>3</sup>Noise level increases with increasing duty cycle of Hold Command. Noise figures shown for Track mode are measured with input grounded and filters for frequencies shown on output.
- <sup>4</sup>V<sub>IN</sub> = 20V p-p, 200kHz sine wave; R<sub>L</sub> = 1kΩ; Mode Control = Track.
- <sup>5</sup>The relationship between the device package and outside environment (θ<sub>ca</sub>) varies with the application. Value shown is based on measuring case temperature with supply voltages applied to a device installed in a ZIF socket mounted on a standard "EJ" burn-in board.
- <sup>6</sup>MTBF calculated for /883B unit using MIL-HNBK 217D; Ground Fixed; Temperature (Ambient) = +25°C. Specifications subject to change without notice.

**ABSOLUTE MAXIMUM RATINGS**

- Supply Voltages
- ±V<sub>S</sub> . . . . . ±18V
- V<sub>CC</sub> . . . . . -0.5, +7V
- Storage Temperature . . . -65°C to +150°C
- Junction Temperature . . . +150°C (A & AM)
- Junction Temperature . . . . . +165°C (/883B units)
- Lead Soldering (10sec) . . . . . +300°C
- Digital Inputs . . . . . -0.5V to V<sub>CC</sub>
- Analog Input . . . . . ±15V

**Explanation of Group A Military Subgroups**

- Subgroup 1 – Static tests at +25°C. (10% PDA calculated against Subgroup 1 for high-rel versions)
- Subgroup 2 – Static tests at maximum rated temperature.
- Subgroup 3 – Static tests at minimum rated temperature.
- Subgroup 4 – Dynamic tests at +25°C.
- Subgroup 5 – Dynamic tests at maximum rated temperature.
- Subgroup 6 – Dynamic tests at minimum rated temperature.
- Subgroup 7 – Functional tests at +25°C.
- Subgroup 8 – Functional tests at maximum and minimum rated temperatures.
- Subgroup 9 – Switching tests at +25°C.
- Subgroup 10 – Switching tests at maximum rated temperatures.
- Subgroup 11 – Switching tests at minimum rated temperatures.
- Subgroup 12 – Periodically sample tested.

**TRACK/HOLD FUNCTION TRUTH TABLE**

With logic levels shown at		
HOLD (Pin 11)	HOLD (Pin 12)	Operating Mode of HTC-0300A is
0	0	Track
0	1	Track
1	0	Hold
1	1	Track

**APPLICATIONS**

Track-and-hold (T/H) amplifiers can be used in a wide variety of ways, but the most common application for these units is to place them ahead of an A/D converter. The combination of a T/H and converter is used when the bandwidth of the signal to be digitized is wider than the converter can handle by itself, i.e., the analog input is changing more than one LSB during the converter's conversion interval.

In applications of this type, the HTC-0300A "freezes" the incoming signal on command to present a nonchanging signal at the input stage of the converter.

The HTC-0300A T/H can reduce the aperture window to 100 picoseconds when used with the appropriate A/D. It can also be used for peak-holding functions, simultaneous sampling A/Ds (when combined with analog multiplexers), and other high-speed analog signal processing applications.

**THEORY OF OPERATION**

When operated in the "track" mode, the HTC-0300A functions as an operational amplifier with a gain of -1, following all changes in the analog input signal as they occur.

When a TTL-compatible digital logic "1" is applied to the Hold Command input of the T/H, the inverted analog output of the HTC-0300A is "held" at the value which was present at the time of the Hold Command, plus the aperture time. If the change from the "track" mode to the "hold" mode is accomplished via

Pin 11,  $\overline{\text{Hold}}$  Command input (Pin 12) must be connected to ground.

For applications which require an inverted Hold Command, this "freezing" of the inverted analog output can be accomplished with a digital "0" applied to the  $\overline{\text{Hold}}$  Command (Pin 12) input. In this case, a digital "1" establishes the "track" mode of operation. For these, the Hold Command input (Pin 11) must be connected to +5V.

Refer to Figure 1, the HTC-0300A Track/Hold Waveforms.

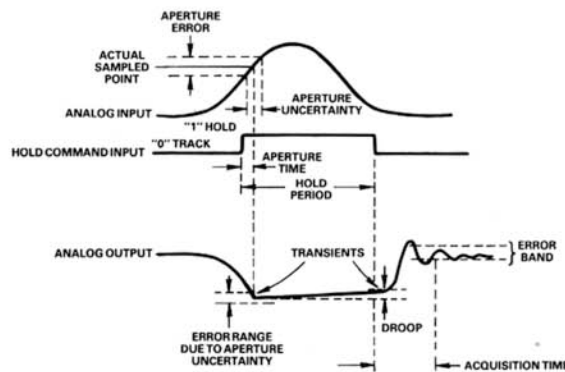

Figure 1. Track/Hold Waveforms - HTC-0300A

Two different intervals of time can affect the point on the analog input which is sampled when the T/H is switched from "track" to "hold". There is no major difference in operation whether this change in state is accomplished via the Hold Command or  $\overline{\text{Hold}}$  Command; the functioning of the HTC-0300A is essentially the same, with only a slight difference in timing because of an additional logic package in the  $\overline{\text{Hold}}$  Command signal path.

The delay interval, aperture time, is a constant and should not be regarded as an error source. The design of the HTC-0300A assures that aperture time is within its spec from unit to unit; and is also repeatable from one "hold" command to the next in any given unit. In this way, aperture time can be compensated with system timing to assure an optimum sampling point.

Aperture uncertainty, or "jitter", is the other interval affecting the held value. It is the result of noise signals which modulate the phase of the hold command and shows up as sample-to-sample variations in the value of the analog signal being "frozen."

As expected, the error resulting from jitter is directly related to the  $dV/dt$  of the analog input. If very-high-speed inputs are sampled, any given value of jitter will result in larger errors in the held value at the output as  $dV/dt$  increases. See Figure 2.

The high feedthrough rejection of the HTC-0300A in the hold mode is an important characteristic; it precludes errors being introduced during the conversion interval of the digitizer.

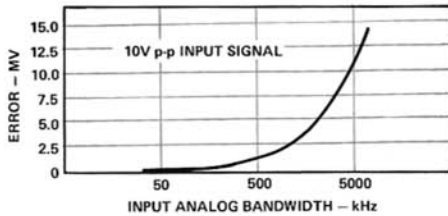

Figure 2. HTC-0300A Error Due to Aperture Uncertainty

As shown in Figure 1, droop is the amount the output changes during the hold period; this is the result of loading on the internal hold capacitor. Low droop rates are important in T/H amplifiers to insure they are appropriate for high-resolution digitizing. Excessive droop rates can negate the effectiveness of having converters of 10 or 12 bits or more. Lower-order bits may be in error because of changes in the held value during the conversion cycle, especially for successive-approximation converters.

The return to the "track" mode is accomplished by changing the digital logic level of the hold command; Figure 1 shows the hold command as it would appear at the (Pin 11) Hold Command input.

Acquisition Time is the interval required for the analog output to re-establish accurate tracking of the changing input and remain within a specified error band around its final value. The greater the change in the input value during the hold period, the longer this interval is. Nyquist sampling is the most stringent application.

Transients shown in Figure 1 are "spikes" which occur at the output of the T/H at the beginning and end of each "hold" period because of switching transients within the unit. When a T/H is used at the output of a D/A converter for "deglitching" discontinuities in the output of the converter, these transients occur at the update rate and can be filtered.

#### SAMPLE-AND-HOLD (S/H) MODE

Although it is generally used in the track-and-hold mode, the HTC-0300A can also be used as a sample-and-hold device. In the S/H mode, the output of the unit is usually in the "hold" mode, but is switched briefly to the "sample" (track) mode.

The width of the the sample pulse applied to the  $\overline{\text{Hold}}$  Command input (or, if using inverted logic, the Hold Command input) is determined by (1) the acquisition time of the HTC-0300A, and (2) the desired accuracy of the sampled output. Output accuracy will also be a function of the amount of change which has occurred since the preceding sample.

This latter phenomenon is illustrated in Figure 3. Note the analog input has changed drastically between the first and second hold commands. There is a considerably smaller change between the third and fourth pulses; as a consequence, movement in the held value of the output is correspondingly smaller.

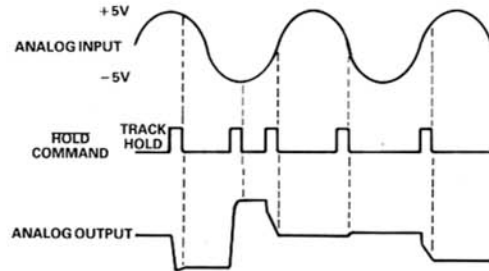

Figure 3. Sample/Hold Operation

Figure 4 illustrates settling accuracy versus acquisition time; closer accuracies require more time. The relationship approaches an asymptotic curve and is not a linear function.

The HTC-0300A is a "closed loop" T/H and is suitable for most applications requiring a track-and-hold for update rates up to 5-10MHz. (Note: 5MHz conversion rates are only a guide and are based on system acquisition time, not logic speed. Higher rates are possible with trade-offs in acquisition time.)

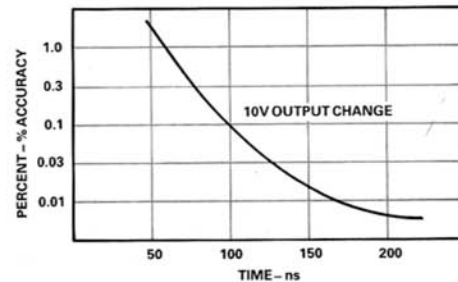

Figure 4. Settling Accuracy vs. Acquisition Time

For optimum performance, the HTC-0300A must have external bypass capacitors connected to the power supply pins close to the device. Electrolytic capacitors of 10 - 22 $\mu$ F and ceramic capacitors of 0.01 - 0.1 $\mu$ F on each supply will enhance performance of the unit.

Output loading has some restrictions. To avoid oscillations, limit capacitive loads to 250pF; the recommended resistive loading is 500 $\Omega$ . Acquisition and settling times are relatively unaffected by capacitive loads up to 50pF and resistive loads down to 250 $\Omega$ .

A massive ground plane, careful component layout, and physically separating digital and analog signals as much as possible are also among the multitude of items which can affect the operation of circuits that include the HTC-0300A T/H.

Cross coupling of analog and digital signals is often a major problem at high frequencies. Relatively low levels of ground plane noise can "mask" lower-order bits when the HTC-0300A is used in high-resolution digitizing. The user must exercise care in electrical and mechanical design to assure satisfactory performance.